

There are a plethora of wedge-shaped handles around. Almost every company makes its own version of this basic shape. The original design of this lever handle is most probably attributable to Professor Max Burchartz. The FSB 1005 design by Johannes Potente is characterised by its slender proportions.

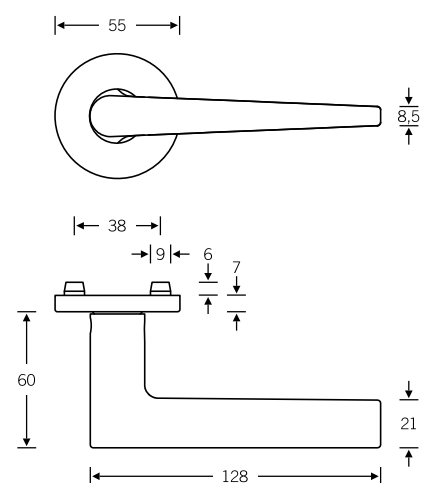

Design: Johannes Potente

Other variants:
– square roses
– oval/angular backplates

Lever handle with privacy function

12 1005

Push-button lock, see page 526 ff.

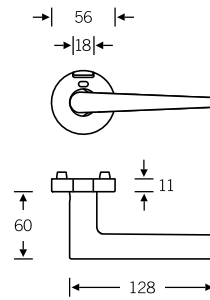

Plug-in handle for doors

15 1005

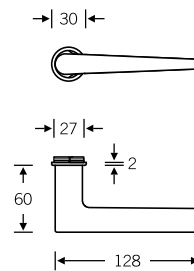

Window handle

Plug-in handle for windows

34 1005

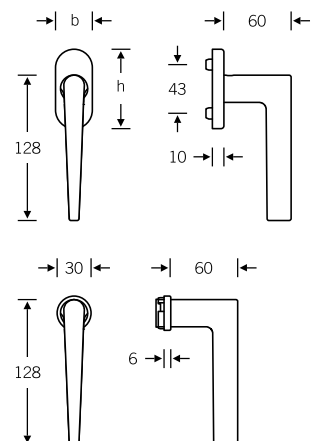

Custom-coordinated lifting/sliding door handle available upon request, see page 10

Lever handles for narrow-stile doors

09 1005 (in-line)

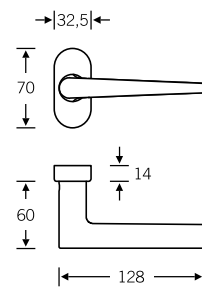

Doorknob for narrow-stile doors

07 0809 (cranked)

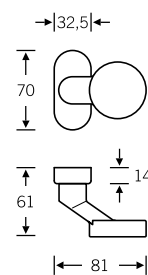

Glass door fitting

13 4220 with 12 1005

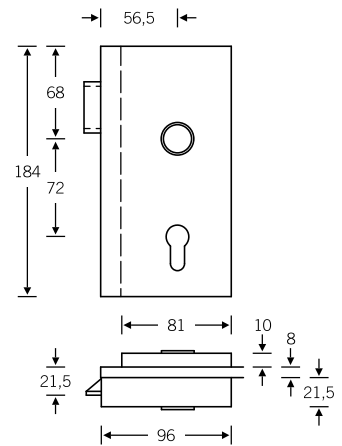

4

Lever/knob sets

Doorknob for flush doors

Knob backplates

Aluminium $\varnothing = 50$
 Stainless steel $\varnothing = 55$
 Bronze $\varnothing = 50$

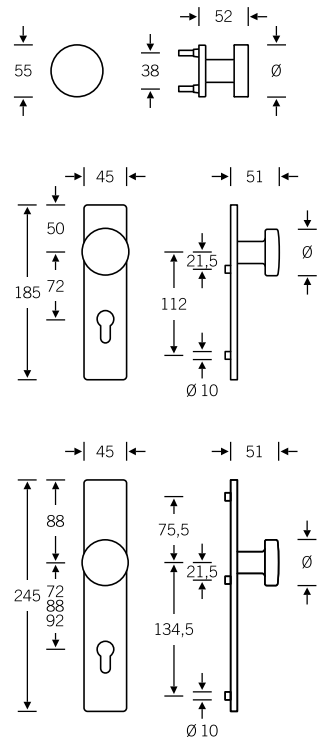

Product codes for the lever/knob sets can be found on the following pages; for individual components, see page 328 ff.

FSB 1005

Lever/lever sets

Broad backplate sets available upon request;
for flush-fitted roses, see page 386 f.

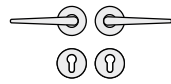

➤ 12 1005 013 (N)

➤ 12 1005 047 (prv)

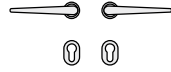

➤ 15 1005 013 (N)

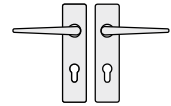

➤ 12 1005 001 (N)

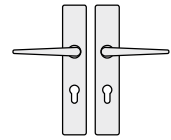

➤ 12 1005 021 (N)

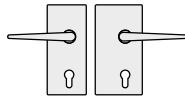

➤ 13 4220 041 (R) with
10 1005 00500 (N)

➤ 13 4220 051 (L) with
10 1005 00500 (N)

➤ 13 4220 042 (R) with
12 1005 013 (N)

➤ 13 4220 052 (L) with
12 1005 013 (N)

Sets for narrow-stile doors



➤ 09 1005 111

➤ 09 1005 112 (refit to ILS possible)



➤ 07 0809 228 (fixed; aluminium and stainless steel)

➤ 07 0809 228 (fixed; stainless steel and bronze)

➤ 07 0809 428 (fixed; aluminium)



17 1757

Lever/knob sets

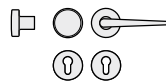

12 1005 017 (N)

Broad backplate sets available upon request

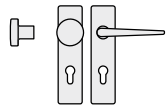

12 1005 003 (N)

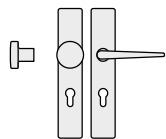

12 1005 023 (N)

WC sets

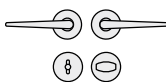

12 1005 019 (N)

Broad backplate sets available upon request;
for flush-fitted roses, see page 386 f.

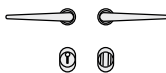

15 1005 019 (N)

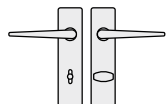

12 1005 005 (N)

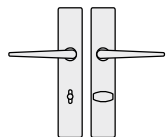

12 1005 025 (N)

Window handles



- 34 1005 09030 (rose 27 × 62 × 10)
- 34 1005 09039 (rose 32.5 × 70 × 10)
- 34 1005 09034 (rose 25.5 × 60.5 flush-fitted)
- 34 1005 170 (lock adaptor RC 1–6)
- 34 1005 076 (lock adaptor with push-button RC 1–6)
- 34 1005 711 (plug-in handle for timber/metal profiles, Ø 30)
- 34 1005 751 (plug-in handle for PVC profiles, Ø 30)

Custom-coordinated lifting/sliding door
handle available upon request, see page 10

N = non-handed
prv = lever handle with privacy function
R = DIN RH, opening inwards
L = DIN LH, opening inwards
ILS = inactive-leaf set

♀ Female handles
♂ Plug-in handle for doors
♂ FSB ASL®

♂ FSB AGL®
♂ FS heavy-duty fitting
♂ EN 179 heavy-duty fitting

For bearings, see page 52 ff.