

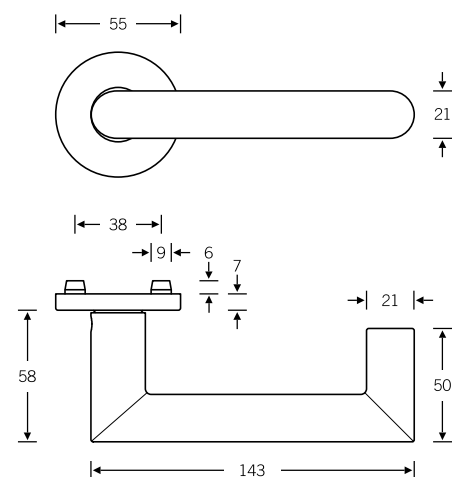

The 1076 model FSB launched in 1990, a lever handle design with its roots in the 1920s, became the most copied lever handle of the century. The version shown here, the FSB 1016, is a more enclosed counterpart to it.



 EN 179 model:
Lever handle with return-to-door

Other variants:
 – square roses
 – oval/angular backplates

Lever handle with privacy function

12 1016

Push-button lock, see page 526 ff.

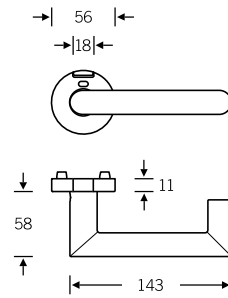

Plug-in handle for doors

15 1016

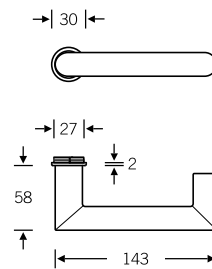

Window handle

Plug-in handle for windows

34 1076

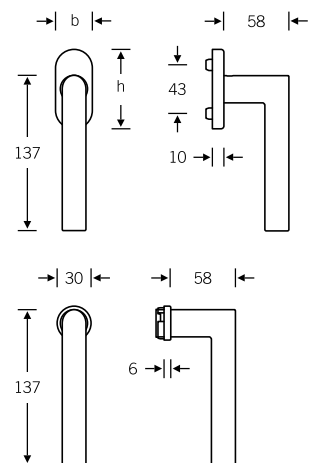

Lifting/sliding door handle

34 1016 011

For more variants, see page 443
For parallel slide/tilt fitting, see page 439

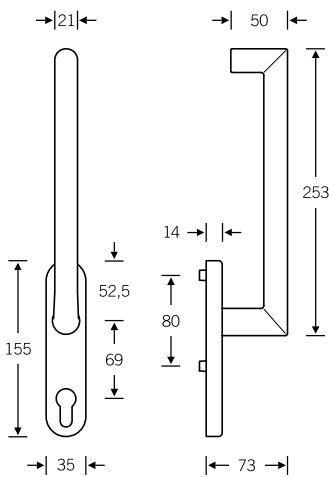

Lever handles
for narrow-stile doors

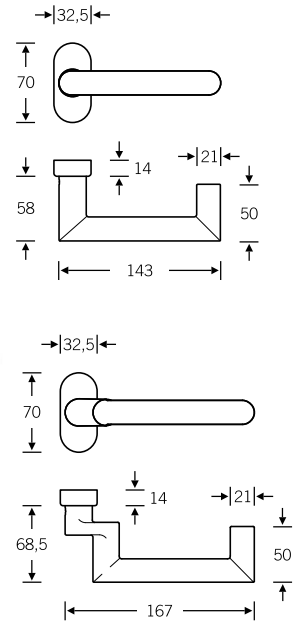

09 1016 (in-line, EN 179)
06 1016 (cranked, EN 179)

Doorknob
for narrow-stile doors

07 0809 (cranked)

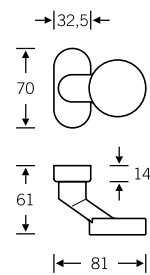

Glass door fitting

13 4220 with 72 1016

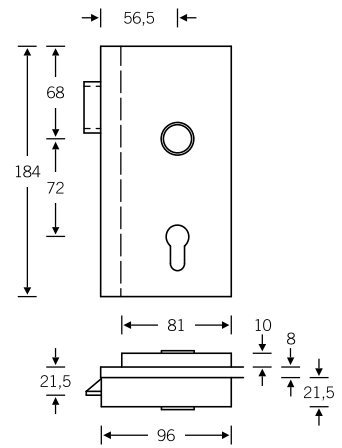

4

Lever/knob sets

Doorknob for flush doors

Knob backplates

- Aluminium $\varnothing = 50$
- Stainless steel $\varnothing = 55$
- Bronze $\varnothing = 50$

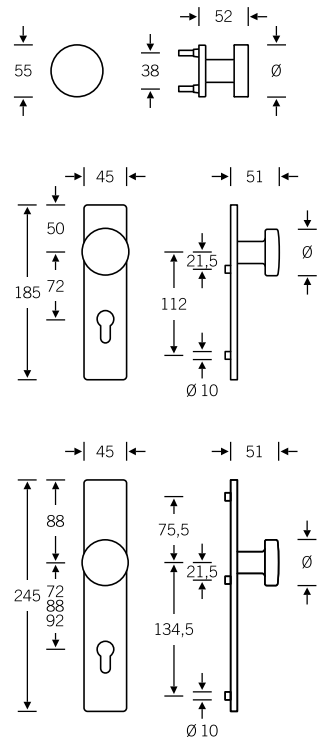

Product codes for the lever/knob sets can be found on the following pages; for individual components, see page 328 ff.

Lever/lever sets

Broad backplate sets available upon request; for flush-fitted roses, see page 386 f.

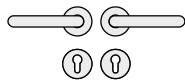

12 1016 013 (N)
 72 1016 613 (R)
 79 1016 613 (R)

12 1016 047 (prv)
 72 1016 614 (L)
 79 1016 614 (L)

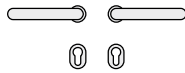

15 1016 013 (N)

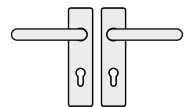

12 1016 001 (N)
 72 1016 601 (R)
 79 1016 601 (R)

72 1016 602 (L)
 79 1016 602 (L)

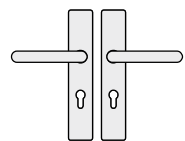

12 1016 021 (N)
 72 1016 621 (R)
 79 1016 621 (R)

72 1016 622 (L)
 79 1016 622 (L)

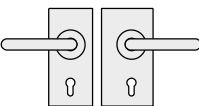

13 4220 041 (R) with
 10 1016 00500 (N)
 13 4220 042 (R) with
 12 1016 013 (N)
 13 4220 042 (R) with
 72 1016 613 (R)*
 13 4220 090* with
 79 1016 913 (N)

13 4220 051 (L) with
 10 1016 00500 (N)
 13 4220 052 (L) with
 12 1016 013 (N)
 13 4220 052 (L) with
 72 1016 614 (L)*

Sets for narrow-stile doors



09 1016 111
 09 1016 112 (refit to ILS possible)

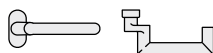

06 1016 011
 06 1016 012

06 1016 023 (ILS)



07 0809 228 (fixed; aluminium and stainless steel)
 07 0809 228 (fixed; stainless steel)
 07 0809 428 (fixed; aluminium)



17 1757

* Fire safety and EN 179 variants available only in stainless steel; for variants, see page 508

Lever/knob sets

Broad backplate sets available upon request

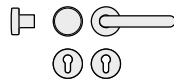

- 12 1016 017 (N)
- 72 1016 617 (R)
- 79 1016 617 (R)
- 79 1016 619 (ILS)
- 72 1016 618 (L)
- 79 1016 618 (L)

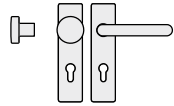

- 12 1016 003 (N)
- 72 1016 603 (R)
- 79 1016 603 (R)
- 79 1016 605 (ILS)
- 72 1016 604 (L)
- 79 1016 604 (L)

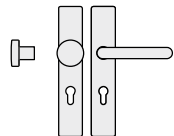

- 12 1016 023 (N)
- 72 1016 623 (R)
- 79 1016 623 (R)
- 79 1016 625 (ILS)
- 72 1016 624 (L)
- 79 1016 624 (L)

WC sets

Broad backplate sets available upon request;
for flush-fitted roses, see page 386 f.

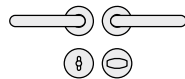

- 12 1016 019 (N)
- 72 1016 619 (R)
- 72 1016 620 (L)

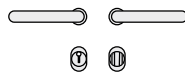

- 15 1016 019 (N)

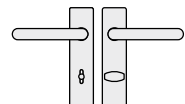

- 12 1016 005 (N)
- 72 1016 605 (R)
- 72 1016 606 (L)

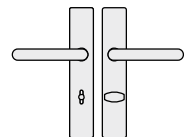

- 12 1016 025 (N)
- 72 1016 625 (R)
- 72 1016 626 (L)

Window handles

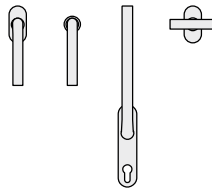

- 34 1076 09030 (rose 27 × 62 × 10)
- 34 1076 09039 (rose 32.5 × 70 × 10)
- 34 1076 09034 (rose 25.5 × 60.5 flush-fitted)
- 34 1076 170 (lock adaptor RC 1–6)
- 34 1076 076 (lock adaptor with push-button RC 1–6)
- 34 1076 711 (plug-in handle, timber/metal profiles, Ø 30)
- 34 1076 751 (plug-in handle for PVC profiles, Ø 30)
- 34 1076 714 (plug-in handle, lock adaptor RC 1–6)
- 34 1076 717 (plug-in handle with push-button RC 1–6)
- 34 3403 (tee handle for window)
- 34 1016 011 (lifting/sliding door handle)

N = non-handed
 prv = lever handle with privacy function
 R = DIN RH, opening inwards
 L = DIN LH, opening inwards
 ILS = inactive-leaf set

Female handles
 Plug-in handle for doors
 FSB ASL®

FSB AGL®
 FS heavy-duty fitting
 EN 179 heavy-duty fitting

For bearings, see page 52 ff.