

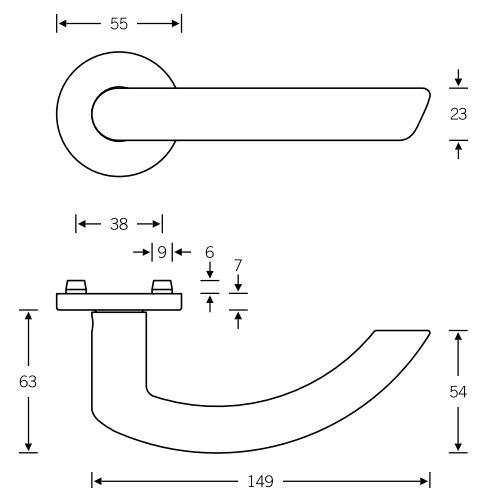

The FSB 1119 incorporates insights gained by FSB in cooperation with the Fraunhofer institute (FSB 1155). Whereas the utmost importance was given to the rigorous implementation of ergonomic parameters for the FSB 1155, considerations of style predominated in the case of the FSB 1119.



Design: Hartmut Weise
 Pictured: right-hand model

 EN 179 model:
 Lever handle with return-to-door

Other variants:
 – square roses
 – oval/angular backplates

Lever handle with privacy function

12 1119

Push-button lock, see page 526 ff.

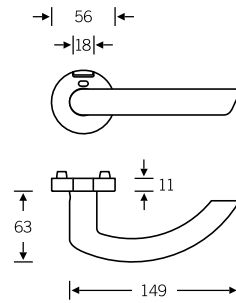

Plug-in handle for doors

15 1119

4

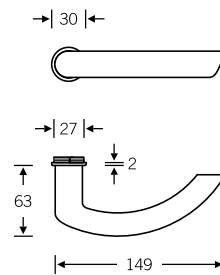

Window handle

Plug-in handle for windows

34 1107

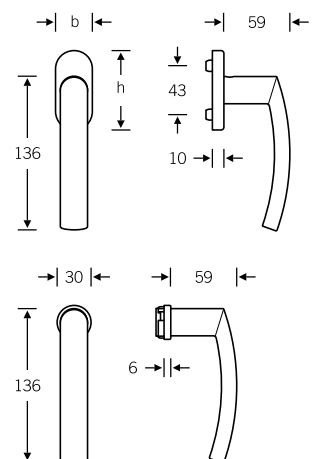

Lever handles for narrow-stile doors

09 1119 (in-line, EN 179)
06 1119 (cranked, EN 179)

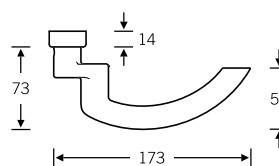
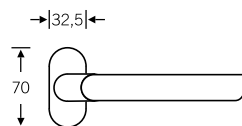
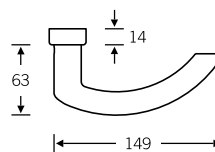
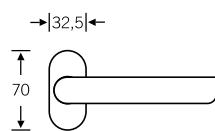

Doorknob for narrow-stile doors

07 0846 (cranked)

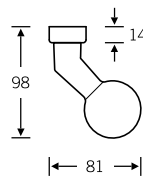
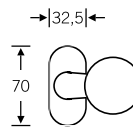

Glass door fitting

13 4223 with 72 1119

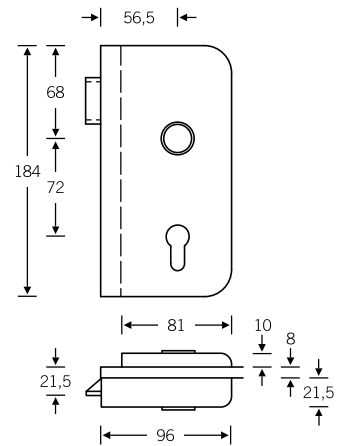

4

Lever/knob sets

Doorknob for flush doors

Knob backplates

Aluminium X = 77 mm
 Stainless steel X = 73 mm
 Bronze X = 72 mm

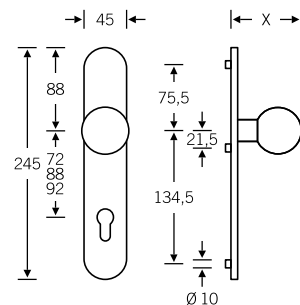
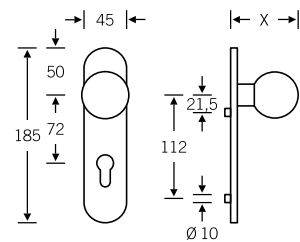
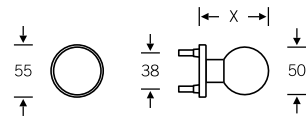

Product codes for the lever/knob sets can be found on the following pages; for individual components, see page 328 ff.

Lever/lever sets

Broad backplate sets available upon request; for flush-fitted roses, see page 386 f.

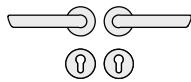

12 1119 013 (N)
 72 1119 613 (R)
 79 1119 613 (R)

12 1119 047 (prv)
 72 1119 614 (L)
 79 1119 614 (L)

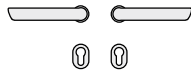

15 1119 013 (N)

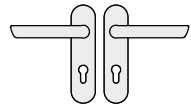

12 1119 007 (N)
 72 1119 607 (R)
 79 1119 607 (R)

72 1119 608 (L)
 79 1119 608 (L)

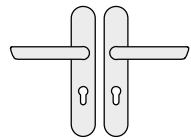

12 1119 027 (N)
 72 1119 627 (R)
 79 1119 627 (R)

72 1119 628 (L)
 79 1119 628 (L)

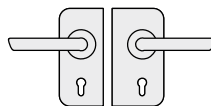

13 4223 041 (R) with
 10 1119 00500 (N)
 13 4223 042 (R) with
 12 1119 013 (N)
 13 4223 042 (R) with
 72 1119 613 (R)

13 4223 051 (L) with
 10 1119 00500 (N)
 13 4223 052 (L) with
 12 1119 013 (N)
 13 4223 052 (L) with
 72 1119 614 (L)

Sets for narrow-stile doors

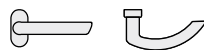

09 1119 11144 (R)
 09 1119 11264 (R)*
 09 1119 12364 (ILS, R)

09 1119 11145 (L)
 09 1119 11265 (L)*
 09 1119 12365 (ILS, L)

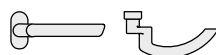

06 1119 01144 (R)
 06 1119 01264 (R)
 06 1119 02364 (ILS, R)

06 1119 01145 (L)
 06 1119 01265 (L)
 06 1119 02365 (ILS, L)



07 0846 228 (fixed; aluminium, stainless steel and
 bronze)
 07 0846 228 (fixed; stainless steel and bronze)
 07 0846 428 (fixed; aluminium)







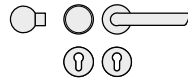

17 1757

* Refit to ILS possible

Lever/knob sets







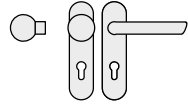

 12 1119 015 (R)
 72 1119 615 (R)
 79 1119 615 (R)
 79 1119 619 (ILS)

 12 1119 016 (L)
 72 1119 616 (L)
 79 1119 616 (L)





Broad backplate sets available upon request



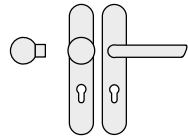

 12 1119 009 (R)
 72 1119 609 (R)
 79 1119 609 (R)
 79 1119 611 (ILS)

 12 1119 010 (L)
 72 1119 610 (L)
 79 1119 610 (L)





 12 1119 029 (R)
 72 1119 629 (R)
 79 1119 629 (R)
 79 1119 631 (ILS)

 12 1119 030 (L)
 72 1119 630 (L)
 79 1119 630 (L)

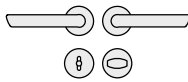
WC sets



 12 1119 019 (N)
 72 1119 619 (R)

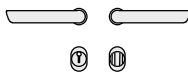

 72 1119 620 (L)

Broad backplate sets available upon request;
for flush-fitted roses, see page 386 f.



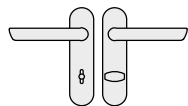

 15 1119 019 (N)

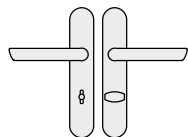

 12 1119 011 (N)
 72 1119 611 (R)

 72 1119 612 (L)



 12 1119 031 (N)
 72 1119 631 (R)



 72 1119 632 (L)



Window handles



34 1107 09030 (rose 27 × 62 × 10)
 34 1107 09039 (rose 32.5 × 70 × 10)
 34 1107 09034 (rose 25.5 × 60.5 flush-fitted)
 34 1107 170 (lock adaptor RC 1–6)
 34 1107 076 (lock adaptor with push-button RC 1–6)
 34 1107 711 (plug-in handle for timber/metal profiles,
 Ø 30)
 34 1107 751 (plug-in handle for PVC profiles, Ø 30)

N = non-handed
 prv = lever handle with privacy function
 R = DIN RH, opening inwards
 L = DIN LH, opening inwards
 ILS = inactive-leaf set

 Female handles
 Plug-in handle for doors
 FSB ASL®

 FSB AGL®
 FS heavy-duty fitting
 EN 179 heavy-duty fitting

For bearings, see page 52 ff.