

True to the adage that simple is (usually) best, architectural firm gmp have designed a door handle with particularly pared-down credentials. The FSB 1244 incorporates the simplest of geometric shapes. Its linear front face takes on the curvature of its neck on one end and closes it with a square finish on the other. The grip cross-section is made up of half a circle and half a square, a compound shape that gives the hand something pleasant and substantial to grasp.

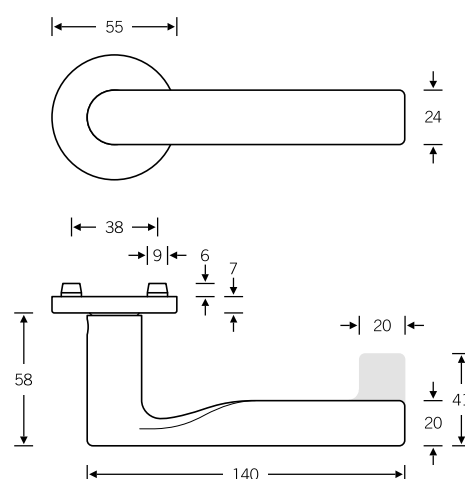

Design: von Gerkan, Marg and Partners (gmp)

EN 179 model: FSB 1245
Lever handle with return-to-door

Other variants:
– square roses
– oval/angular backplates

Lever handle with privacy function

12 1244

Push-button lock, see page 526 ff.

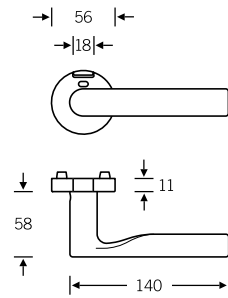

Plug-in handle for doors

15 1244

4

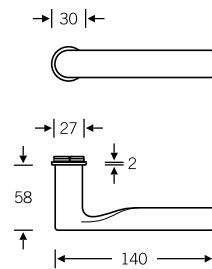

Window handle

Plug-in handle for windows

34 1244

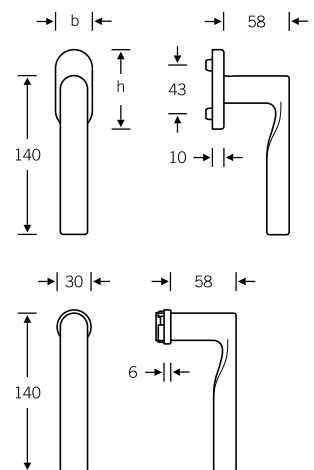

Custom-coordinated lifting/sliding door handle available upon request, see page 10

Lever handles for narrow-stile doors

09 1245 (in-line, EN 179)
06 1245 (cranked, EN 179)

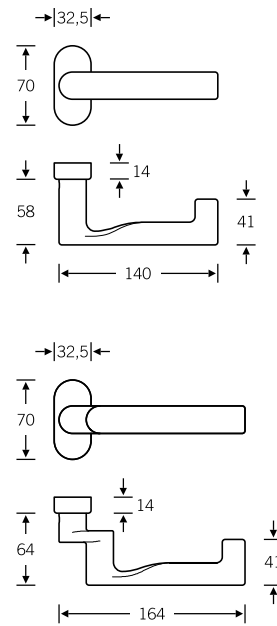

Doorknob for narrow-stile doors

07 0809 (cranked)

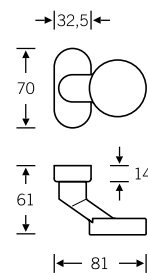

Glass door fitting

13 4220 with 72 1244

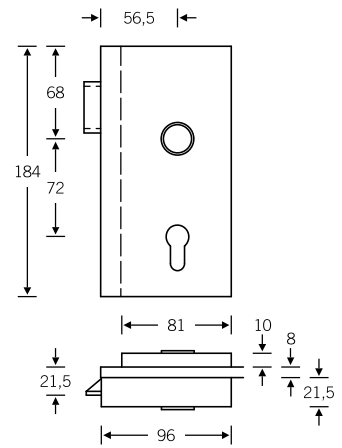

4

Lever/knob sets

Doorknob for flush doors

Knob backplates

Aluminium $\varnothing = 50$
Stainless steel $\varnothing = 55$

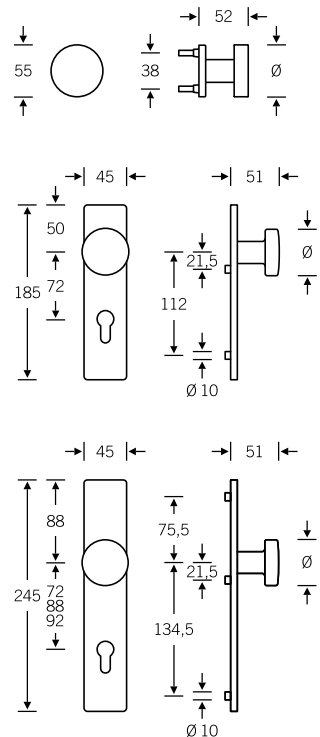

Product codes for the lever/knob sets can be found on the following pages; for individual components, see page 328 ff.

Lever/lever sets

Broad backplate sets available upon request; for flush-fitted roses, see page 536 f.

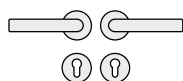

- 🔑 12 1244 013 (N)
- 🔑 72 1244 613 (R)
- 🔑 76 1244 613 (R)
- 🔑 79 1245 613 (R)

- 🔑 12 1244 047 (prv)
- 🔑 72 1244 614 (L)
- 🔑 76 1244 614 (L)
- 🔑 79 1245 614 (L)

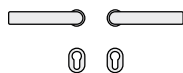

- 🔑 15 1244 013 (N)

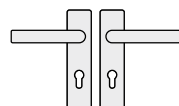

- 🔑 12 1244 001 (N)
- 🔑 72 1244 601 (R)
- 🔑 76 1244 601 (R)
- 🔑 79 1245 601 (R)

- 🔑 72 1244 602 (L)
- 🔑 76 1244 602 (L)
- 🔑 79 1245 602 (L)

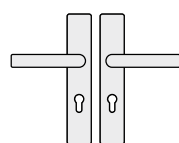

- 🔑 12 1244 021 (N)
- 🔑 72 1244 621 (R)
- 🔑 76 1244 621 (R)
- 🔑 79 1245 621 (R)

- 🔑 72 1244 622 (L)
- 🔑 76 1244 622 (L)
- 🔑 79 1245 622 (L)

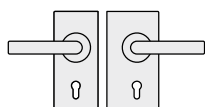

- 🔑 13 4220 041 (R) with 10 1244 00500 (N)
- 🔑 13 4220 042 (R) with 12 1244 013 (N)
- 🔑 13 4220 042 (R) with 72 1244 613 (R)
- 🔑 13 4220 090* with 76 1244 613 (R)
- 🔑 13 4220 090* with 79 1245 913 (N)

- 🔑 13 4220 051 (L) with 10 1244 00500 (N)
- 🔑 13 4220 052 (L) with 12 1244 013 (N)
- 🔑 13 4220 052 (L) with 72 1244 614 (L)
- 🔑 13 4220 090* with 76 1244 614 (L)

Sets for narrow-stile doors



- 🔑 09 1245 111
- 🔑 09 1245 112 (refit to ILS possible)



- 🔑 06 1245 011
- 🔑 06 1245 012

- 🔑 06 1245 023 (ILS)



- 🔑 07 0809 228 (fixed; aluminium and stainless steel)
- 🔑 07 0809 228 (fixed; stainless steel)
- 🔑 07 0809 428 (fixed; aluminium)



- 🔑 17 1757

* Fire safety and EN 179 variants available only in stainless steel; for variants, see page 508

Lever/knob sets

Broad backplate sets available upon request; for flush-fitted roses, see page 536 f.

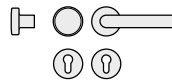

- | | |
|-------------------|-----------------|
| 12 1244 017 (N) | 72 1244 618 (L) |
| 72 1244 617 (R) | 76 1244 618 (L) |
| 76 1244 617 (R) | 79 1245 618 (L) |
| 79 1245 617 (R) | |
| 79 1245 619 (ILS) | |

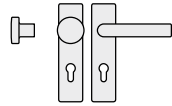

- | | |
|-------------------|-----------------|
| 12 1244 003 (N) | 72 1244 604 (L) |
| 72 1244 603 (R) | 76 1244 604 (L) |
| 76 1244 603 (R) | 79 1245 604 (L) |
| 79 1245 603 (R) | |
| 79 1245 605 (ILS) | |

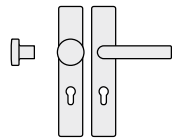

- | | |
|-------------------|-----------------|
| 12 1244 023 (N) | 72 1244 624 (L) |
| 72 1244 623 (R) | 76 1244 624 (L) |
| 76 1244 623 (R) | 79 1245 624 (L) |
| 79 1245 623 (R) | |
| 79 1245 625 (ILS) | |

WC sets

Broad backplate sets available upon request; for flush-fitted roses, see page 536 f.

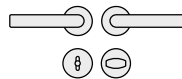

- | | |
|-----------------|-----------------|
| 12 1244 019 (N) | 72 1244 620 (L) |
| 72 1244 619 (R) | |

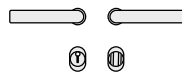

- | |
|-----------------|
| 15 1244 019 (N) |
|-----------------|

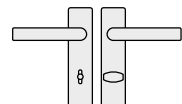

- | | |
|-----------------|-----------------|
| 12 1244 005 (N) | 72 1244 606 (L) |
| 72 1244 605 (R) | |

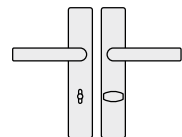

- | | |
|-----------------|-----------------|
| 12 1244 025 (N) | 72 1244 626 (L) |
| 72 1244 625 (R) | |

Window handles

Custom-coordinated lifting/sliding door handle available upon request, see page 10



- 34 1244 09030 (rose 27 × 62 × 10)
- 34 1244 09039 (rose 32.5 × 70 × 10)
- 34 1244 09034 (rose 25.5 × 60.5 flush-fitted)
- 34 1244 170 (lock adaptor RC 1–6)
- 34 1244 076 (lock adaptor with push-button RC 1–6)
- 34 1244 711 (plug-in handle for timber/metal profiles, Ø 30)
- 34 1244 751 (plug-in handle for PVC profiles, Ø 30)
- 34 1244 714 (plug-in handle, lock adaptor RC 1–6)
- 34 1244 717 (plug-in handle with push-button RC 1–6)

N = non-handed
 prv = lever handle with privacy function
 R = DIN RH, opening inwards
 L = DIN LH, opening inwards
 ILS = inactive-leaf set

Female handles
 Plug-in handle for doors
 FSB ASL®

FSB AGL®
 FS heavy-duty fitting
 EN 179 heavy-duty fitting

For bearings, see page 52 ff.