



**halliday  
baillie**

## 1520/8813 45mm PZW

### 45mm BACKSET MORTICE PRIVACY LOCK & LATCH

SSF Locks (part of the FSB group of companies) are designed and made in Germany to the highest engineering standards. Locks provided by Halliday + Baillie are for 'high usage doors' to provide additional durability.

SSF Locks and Latches are designed specifically for use with FSB door furniture and includes heavy duty springing to ensure lever stability and superior performance over time.

The 1520/8813 45mm backset mortice lock and latch is ideal for use on both interior and exterior doors, or for glazed doors where there is a narrow stile dimension. This is particularly useful for aluminium and steel joinery.

Handing for all FSS locks and latches is easily changed on site WITHOUT opening the lock or latch case. Opening the lock or latch case will void the warranty. Please see specific handing sheets available on [www.hallidaybaillie.com](http://www.hallidaybaillie.com).

A full range of standard and rebated strike plates are available for all locks and latches and are sold separately. Please note cylinders are also sold separately to the mortice lock as these are ordered specific to the door thickness.

Please see the drawing opposite for cut out dimensions.

Available in the following finishes :

SS : Stainless Steel (as standard)

Please see mortice finish sheet for black, bronze and brass finishes

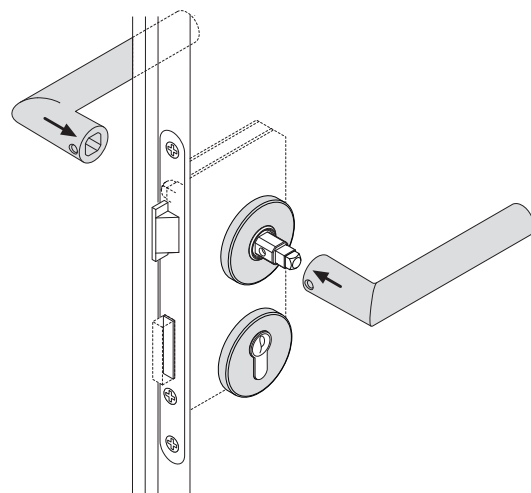
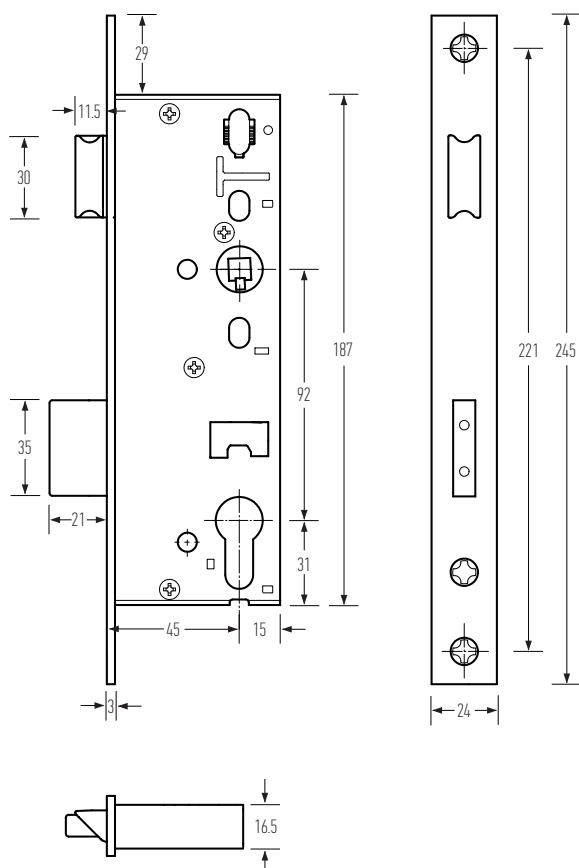

Supplied by Halliday + Baillie. For more information, installation templates, and measured drawings of this product and others please visit : [www.hallidaybaillie.com](http://www.hallidaybaillie.com) or contact your authorized Halliday + Baillie dealer. All information subject to change.