

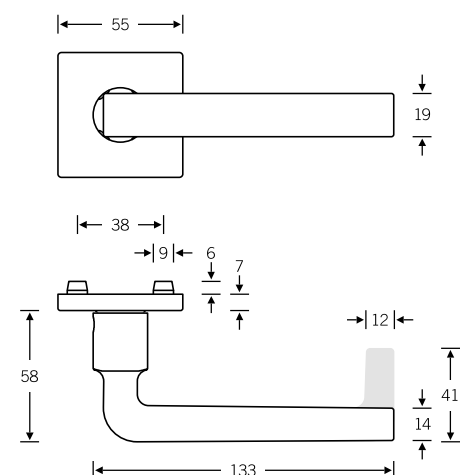

FSB 1004 by David Chipperfield bears the hallmark of the Modernist pioneers. It is underpinned by a clean-lined formal concept that meets all functional requirements giving expression to his formal idea in both public and private spheres.



Design: David Chipperfield

 EN 179 model: FSB 1134
Lever handle with return-to-door

Other variants:
 – round roses
 – oval/angular backplates

Lever handle with privacy function

12 1004

Push-button lock, see page 526 ff.

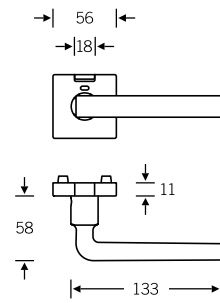

Plug-in handle for doors

15 1004

4

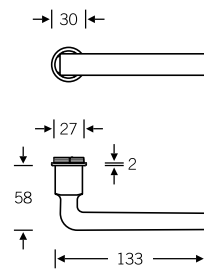

Window handle

Plug-in handle for windows

34 1004

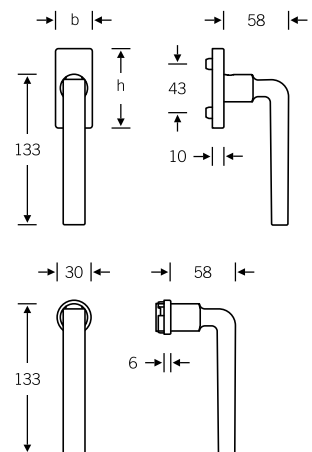

Lifting/sliding door handle

34 1004 021

For more variants, see page 442

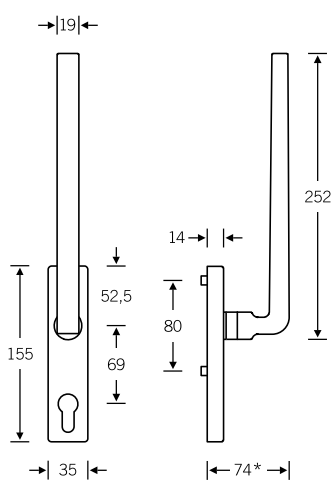

* Aluminium and bronze 74 mm, stainless steel 71 mm

Lever handles for narrow-stile doors



09 1134 (in-line, EN 179)
06 1134 (cranked, EN 179)

Option without return-to-door:
09 1004 (in-line)

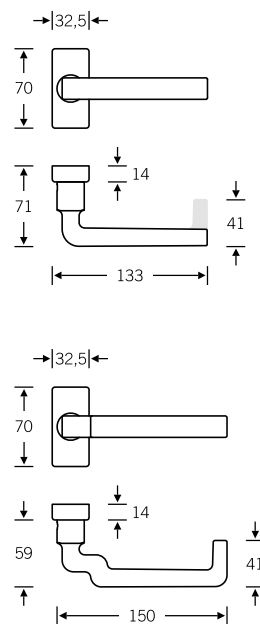

Doorknob for narrow-stile doors

07 0812 (cranked)

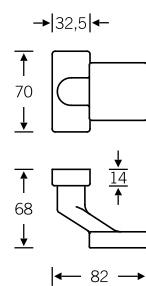

Glass door fitting

13 4220 with 72 1004

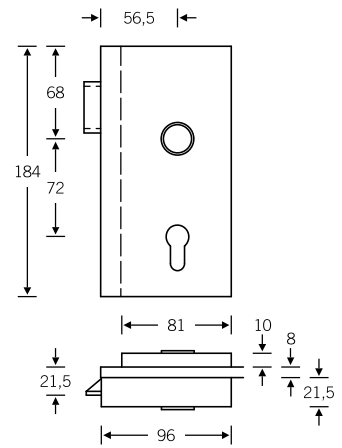

4

Lever/knob sets

Doorknob for flush doors

Knob backplates

- Aluminium $\varnothing = 50$
- Stainless steel $\varnothing = 55$
- Bronze $\varnothing = 50$

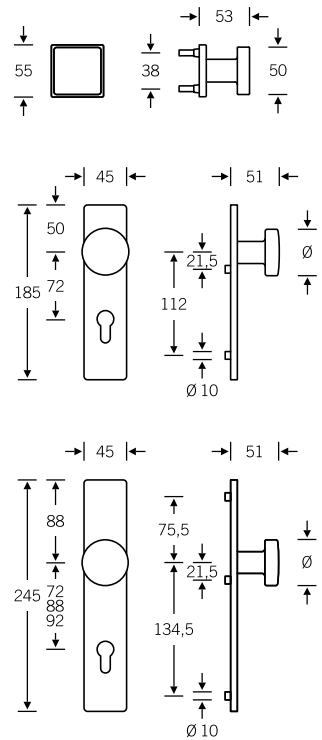

Product codes for the lever/knob sets can be found on the following pages; for individual components, see page 328 ff.

Lever/lever sets

Broad backplate sets available upon request; for flush-fitted roses, see page 536 f.

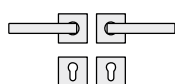

- 🔑 12 1004 041 (N)
- 🔑 72 1004 641 (R)
- 🔑 76 1004 639 (R)
- 🔑 79 1134 639 (R)

- 🔑 12 1004 049 (prv)
- 🔑 72 1004 642 (L)
- 🔑 76 1004 640 (L)
- 🔑 79 1134 640 (L)

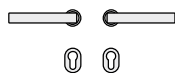

- 🔑 15 1004 013 (N)

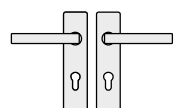

- 🔑 12 1004 001 (N)
- 🔑 72 1004 601 (R)
- 🔑 76 1004 601 (R)
- 🔑 79 1134 601 (R)

- 🔑 72 1004 602 (L)
- 🔑 76 1004 602 (L)
- 🔑 79 1134 602 (L)

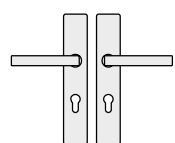

- 🔑 12 1004 021 (N)
- 🔑 72 1004 621 (R)
- 🔑 76 1004 621 (R)
- 🔑 79 1134 621 (R)

- 🔑 72 1004 622 (L)
- 🔑 76 1004 622 (L)
- 🔑 79 1134 622 (L)

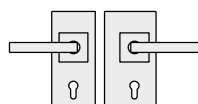

- 🔑 13 4220 041 (R) with 10 1004 00500 (N)
- 🔑 13 4220 042 (R) with 12 1004 041 (N)
- 🔑 13 4220 042 (R) with 72 1004 641 (R)
- 🔑 13 4220 090* with 76 1004 639 (R)
- 🔑 13 4220 090* with 79 1134 939 (N)

- 🔑 13 4220 051 (L) with 10 1004 00500 (N)
- 🔑 13 4220 052 (L) with 12 1004 041 (N)
- 🔑 13 4220 052 (L) with 72 1004 642 (L)
- 🔑 13 4220 090* with 76 1004 640 (L)

Sets for narrow-stile doors

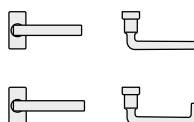

- 🔑 09 1004 171
- 🔑 09 1004 172 (refit to ILS possible)
- 🔑 09 1134 172 (refit to ILS possible)

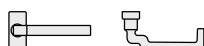

- 🔑 06 1134 071
- 🔑 06 1134 072
- 🔑 06 1134 073 (ILS)



- 07 0812 229 (fixed; aluminium, stainless steel and bronze)
- 🔑 07 0812 229 (fixed; stainless steel and bronze)
- 🔑 07 0812 429 (fixed; aluminium)



- 17 1778

* Fire safety and EN 179 variants available only in stainless steel; for variants, see page 508

Lever/knob sets

Broad backplate sets available upon request;
for flush-fitted roses, see page 536 f.

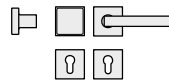

- 12 1004 043 (N)
- 72 1004 643 (R)
- 76 1004 641 (R)
- 79 1134 641 (R)
- 79 1134 643 (ILS)
- 72 1004 644 (L)
- 76 1004 642 (L)
- 79 1134 642 (L)

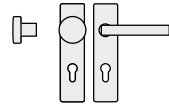

- 12 1004 003 (N)
- 72 1004 603 (R)
- 76 1004 603 (R)
- 79 1134 603 (R)
- 79 1134 605 (ILS)
- 72 1004 604 (L)
- 76 1004 604 (L)
- 79 1134 604 (L)

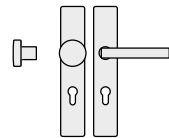

- 12 1004 023 (N)
- 72 1004 623 (R)
- 76 1004 623 (R)
- 79 1134 623 (R)
- 79 1134 625 (ILS)
- 72 1004 624 (L)
- 76 1004 624 (L)
- 79 1134 624 (L)

WC sets

Broad backplate sets available upon request;
for flush-fitted roses, see page 536 f.

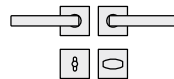

- 12 1004 045 (N)
- 72 1004 645 (R)
- 72 1004 646 (L)

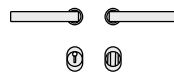

- 15 1004 019 (N)

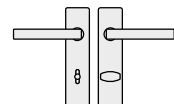

- 12 1004 005 (N)
- 72 1004 605 (R)
- 72 1004 606 (L)

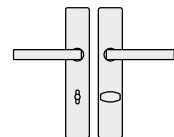

- 12 1004 025 (N)
- 72 1004 625 (R)
- 72 1004 626 (L)

Window handles

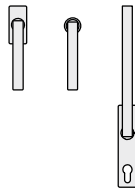

- 34 1004 09032 (rose 27 × 62 × 10)
- 34 1004 09040 (rose 32.5 × 70 × 10)
- 34 1004 09036 (rose 25.5 × 60.5 flush-fitted)
- 34 1004 180 (lock adaptor RC 1–6)
- 34 1004 086 (lock adaptor with push-button RC 1–6)
- 34 1004 711 (plug-in handle for timber/metal profiles, Ø 30)
- 34 1004 751 (plug-in handle for PVC profiles, Ø 30)
- 34 1004 021 (lifting/sliding door handle)

N = non-handed
prv = lever handle with privacy function
R = DIN RH, opening inwards
L = DIN LH, opening inwards
ILS = inactive-leaf set

Female handles
Plug-in handle for doors
FSB ASL®

FSB AGL®
FS heavy-duty fitting
EN 179 heavy-duty fitting

For bearings, see page 52 ff.