

Milling Drawing for timber doors

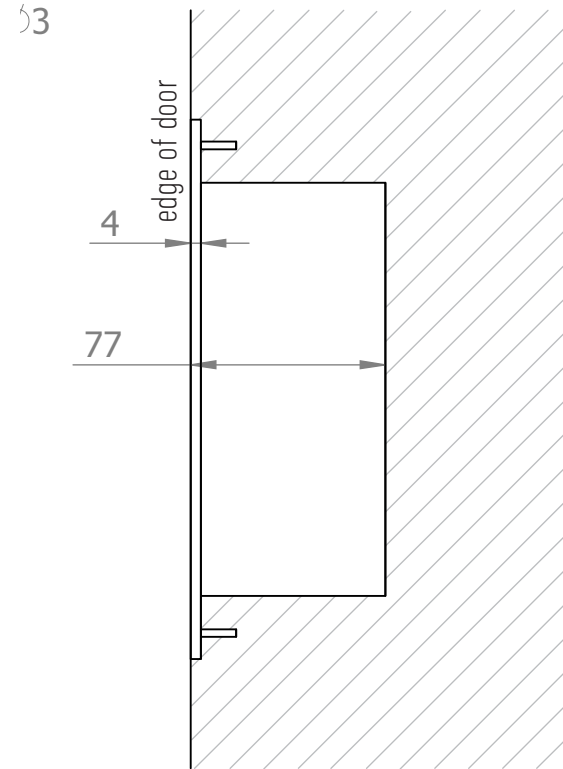
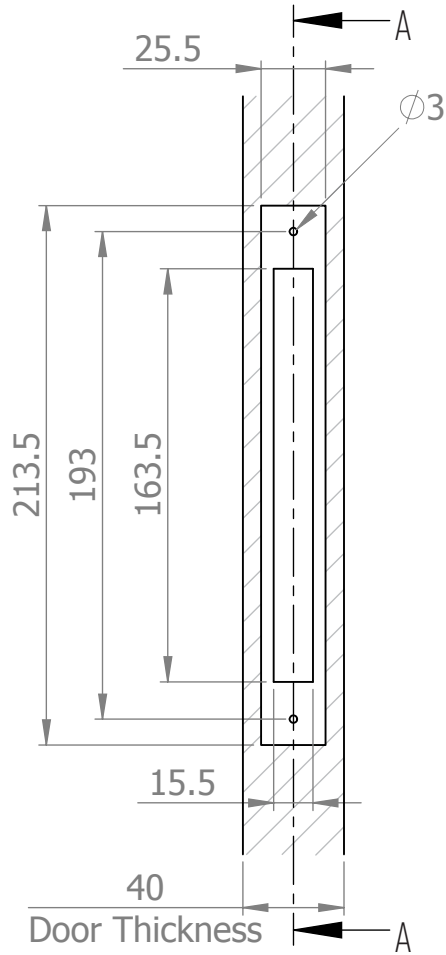

Section A-A

HB 638 - Lock Body
Milling Information for HB 638

Drawings not to scale, all dimensions in mm.

Designed and manufactured in New Zealand. For more information, installation templates, and measured drawings of this product and others please visit : www.hallidaybaillie.com or contact your authorized Halliday + Baillie dealer. All information subject to change.